

StylGame

EQUIPMENT FOR CASINOS AND GAMING

Ergonomic **PLAYER HUB** for an extraordinary gaming experience





discover them on: www.stylgame.com

INDEX

- p. 02 Company
- p. 04 Our Sales Net
- p. 06 Interchangeable Models
- p. 12 Custom Casino Products
- p. 14 Double Seats
- p. 16 Casino&More
- p. 17 Professional Models
- p. 18 Technical Specifications
- p. 20 Installations
- p. 26 Slot Bases
- p. 28 Bingo Division
- p. 30 Service Call
- p. 34 Sportsbook Division
- p. 36 Custom OEM Projects
- p. 38 Protection Separators
- p. 40 Accessories



EQUIPMENT FOR CASINOS AND GAMING



EQUIPMENT FOR CASINOS AND GAMING

OUR PRODUCT LINES



CASINO & GAMING



OEM PARTNERSHIP



CRUISESHIP

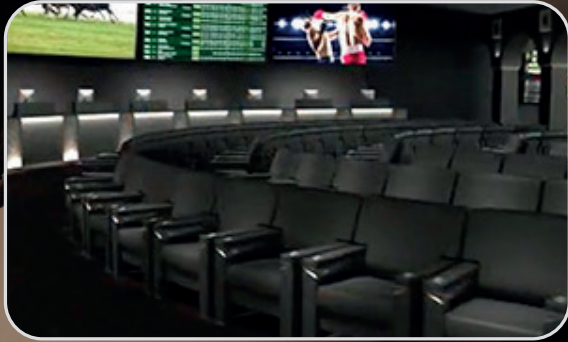

SPORTSBOOK



BINGO



CASINO & MORE



EQUIPMENT FOR CASINOS AND GAMING

WHY CHOOSING US



PLAYER HUB

The choice of an ergonomic PLAYER HUB is crucial to fully express the potential of the slot machine, the gaming tables and in general all the gaming applications, significantly increasing revenues. Comfort is determined by the combination of the following ergonomically designed elements: Ergonomic Cabinet, Slot base, Seat, Accessories.



QUALITY

StylGame guarantees the quality of its products by directly sourcing all raw materials, from steel to the upholsterer's yarn, with a dedicated quality manager constantly monitoring all suppliers. Our products are certified by a third party according to European and international regulations.



COMFORT PLUS®

Thanks to continuous research and experimentation, StylGame is now able to offer a unique and revolutionary material, Comfort Plus®, positioned in between padding and upholstery. The main features are: micro massage, high ventilation, high resistance to deformation, high comfort.

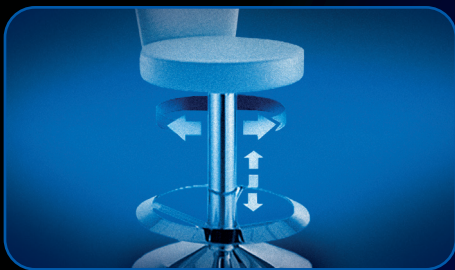

RH ADJUSTABLE SYSTEM

The STYLGAME rotation mechanism is protected by two international patents and in a single container brings together three unique and essential features for the player's comfort: "clutch", "self centering mechanism", "height adjustment".



COIN-IN TEST

In order to prove the effectiveness of its ergonomic research applied to the PLAYER HUB, StylGame proposes to carry out a casinos coin-in test, providing the necessary components free of charge.





CUSTOMIZATIONS

Upon request, StylGame realizes prestigious customizations on its products: special color finishing and color combinations on metal, softness of the personalized seat, tone-on-tone or contrasting decorative stitching, embossed piping and so on.

OUR SALES NET

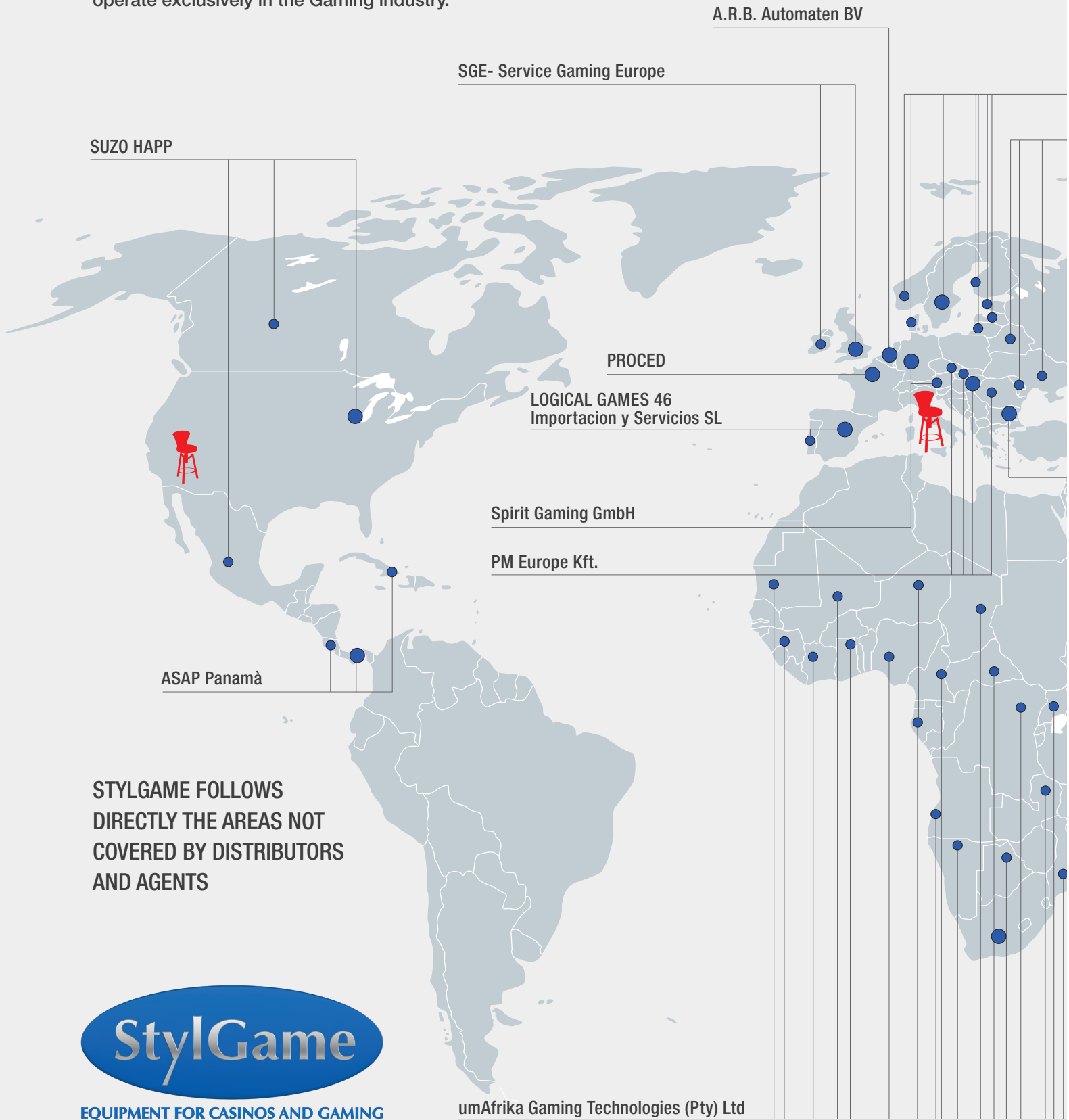
The sales network consists of strategically located offices and a widespread team of distributors and agents who operate exclusively in the Gaming industry.



 **OUR OFFICES**

StylGame Srl
Spilimbergo (PN) Italy
+39.0427.595011 - sales@stylgame.com

StylGame USA LLC
Las Vegas (NV) USA
+1.702.750.0660 - salesusa@stylgame.com

ICM Casinò Management AB

Gaming Supplies LLC

Alfastreet Trade Bg LTD

● OUR SALE NET HEAD OFFICES ● AREAS COVERED BY OUR SALES NET

ALFASTREET TRADE Bg LTD - Samokov (Bulgaria)
Mrs. Desislava Ivanova Petrova +359.29811922 - ubg.bulgaria@gmail.com
Areas: Bulgaria

ARB AUTOMATEN B.V. - Rotterdam (Holland)
Mr. Ron Brouwer +31.104220489 - info@roulettemachines.nl
Areas: Holland

ASAP Panamá - Panama City (Panama)
Mr. Alfredo A. Cuadra +507.3914535 - alfredocuadra@live.com
Areas: Caribbean, Panama, Costa Rica

GAMING SUPPLIES LLC - Batumi (Georgia)
Mr. Yaroslav Roshchin +7.9164442427 - yr@gaming-supplies.com
Mr. Andrey Sharov +7.710.0000917 - aa@gaming-supplies.com
Areas: Belarus, Ukraine, Moldova, Russia, Georgia, Armenia, Kazakhstan

ICM Casino Management AB - Stockholm (Sweden)
Mr. Wolfram Dahlström +46.707480454 - wolfram@icasinomanagement.se
Areas: Norway, Sweden, Finland, Estonia, Latvia, Lithuania, Denmark, Åland

LOGICAL GAMES 46 Importacion y Servicios SL - Barcelona (Spain)
Mr. Miguel Fernández +34.619028628 - mfernandez@logicalgames46.com
Mr. Javier Sevillano +34.588427225 - jsevillano@logicalgames46.com
Areas: Spain, Portugal

PM Europe Kft. - Budaörs (Hungary)
Mr. András Marton +36.703713402 - andras_marton@icloud.com
Areas: Czech Republic, Slovakia, Hungary, Romania

PROCED - Bellefond (France)
Mr. Jean-Luc Profumo +33.687769683 - jlprofumo@proced.fr
Areas: France, French Overseas Departments

SGE SERVICE GAMING EUROPE LTD - Glasgow (England)
Mr. Carlton M. Murphy +44.1355279559 - carlton@segagaming.com
Areas: Ireland, England, Isle of Man, Holland

SPIRIT GAMING GmbH - Kalletal (Germany)
Mr. Frank Ziegler +49.15157122323 - fz@spirit-gaming.de
Mrs. Pauline Ziegler + 49.171 202 8851 - pz@spirit-gaming.de
Areas: Germany, Austria

SUZO HAPP - Mount Prospect, IL (USA)
SuzoHapp Customer Service +1.847.593.6161 - customercare@suzohapp.com
Areas: USA, Canada, Mexico

umAfrika Gaming Technologies (Pty) Ltd - Gauteng (South Africa)
Mr. Anthony Oliver +27.119974200 - anthony.oliver@umafrika.co.za
Areas: Sub-Saharan African countries and Indian Ocean Islands



INTERCHANGEABLE MODELS **SEATS**



SIENA GOLD



FLORENCE



FLORENCE GOLD



FLORENCE ERGO



AMALFI 21



AMALFI FINE DELUXE



VERONA ERGO



RIO



LILLE



ASPEN



MALIBÙ



RECIFE



DALLAS



ROME



LUGANO



SANREMO



MONTREAL



MONTERREY



MAYA



PHOENIX



INTERCHANGEABLE MODELS **FRAMES**



TOWER STAR



TOWER PIN



TOWER



TOWER LIFT



TOWER GAS



TOWER PLUS



CLASSIC



TOWER WHEELS



TOWER FREE



KING



KING LITE



KING PLUS



TOWER FLAT



TOWER SHIFT



TOWER SHIFT PLUS



TAHOE

STYLIGAME



QUEEN



RENO



TUCSON

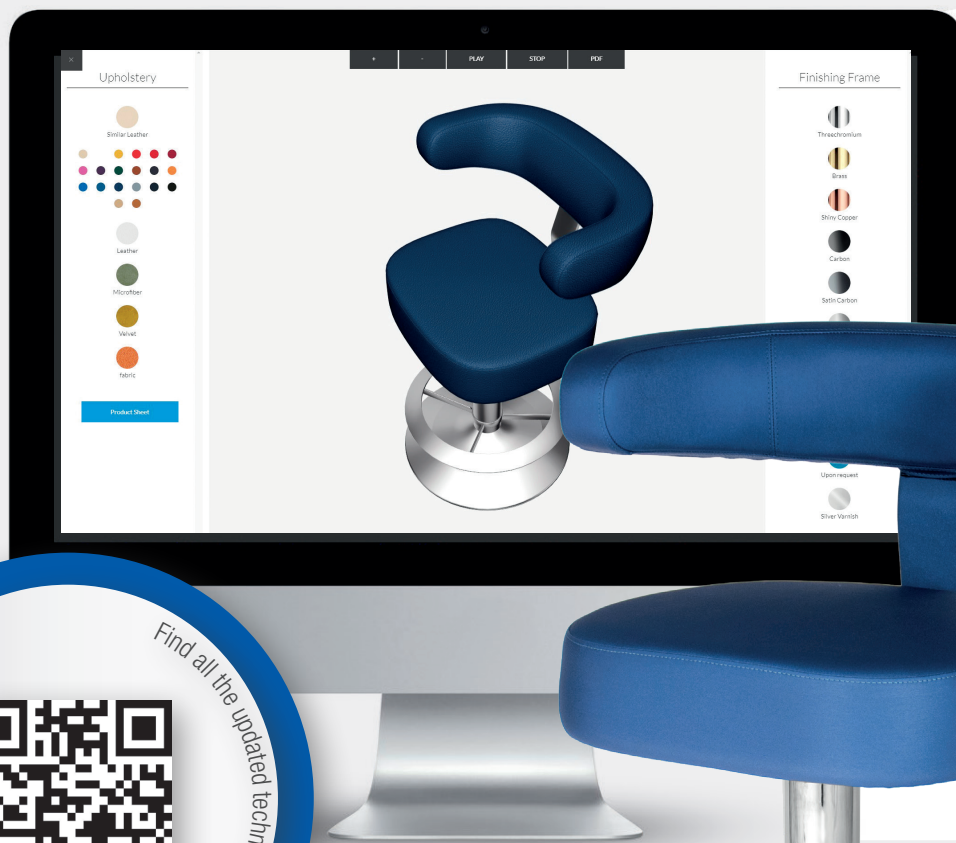

INTERCHANGEABLE MODELS

SEAT/FRAME COMBINATION EXAMPLES



TOWER PIN
RIO



KING
LILLE



TOWER SHIFT
PHOENIX



TUCSON
ASPEN



TOWER PLUS
AMALFI FINE DELUXE



QUEEN
FLORENCE ERGO



TOWER
VERONA ERGO



TOWER WHEELS
MONTERREY

EXAMPLES

CUSTOM **CASINO** PRODUCTS EXAMPLES



PENELOPE



GEORGIA



EMPEROR



MAUI



ANASTASIA



VEGAS VIP



CHARLOTTE



SOFIA



VEGAS



TAMPA

DOUBLE SEATS



SAN FRANCISCO



SAN DIEGO



LONDON CURVE FINE



LONDON CURVE

OPTIONAL



LONDON



LONDON FINE



LONDON STYLE



LONDON MINI



CASINO & MORE ONLINE CATALOGUES

Classic



Contemporary



PROFESSIONAL MODELS



EMPEROR



CHIEF CHAIR



EMPLOYEE GAS



EMPLOYEE LIFT



EMPLOYEE FREE



SIENNA GAS

PROFESSIONAL

TECHNICAL SPECIFICATIONS

UPHOLSTERIES

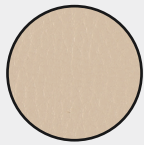

Synthetic PU
Leather

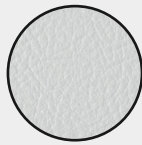

Leather



Microfiber



Breathable
fabric



Velvet

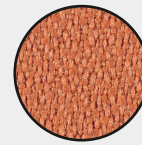

Fabric



Upon request or
supplied by
the customer

METAL - GALVANIC FINISHES AND PAINTS

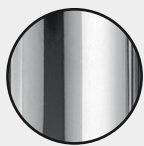

Threechromium

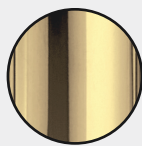

Brass



Carbon



Satin Carbon

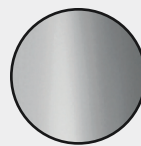

Satin Chrome



Satin Brass



Black Varnish

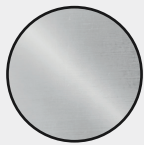

Silver Varnish



Arabesque
Copper



Antique
Brass

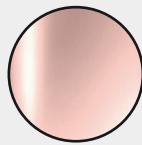

Shiny Copper

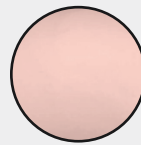

Satin Copper



Upon Request

WOOD - WATER SOLUBLE STAINS



Anthracite



White Wood



Cherry Tree



Beech



Brown
Mahogany



Walnut Cantù



Light Walnut



Red Rosewood



Gray Oak

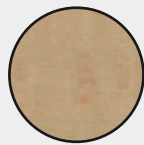

Whitened Oak



Teak



Wenge



Dark Walnut



Upon request or
supplied by
the customer

SEAT HEIGHTS

FIXED HEIGHT SEATS

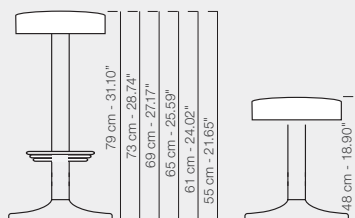

Standard heights available for Classic, King, Tower, Tower Pin, Tower Plus and Tower Fix models

TOWER "RH" HEIGHTS

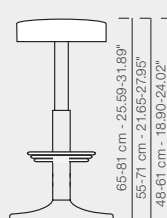

Height adjustable during installation phase

TOWER LIFT HEIGHTS

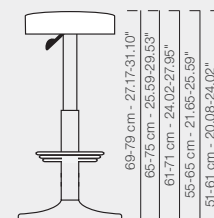

Height adjustable by player

SEAT ROTATION MECHANISMS

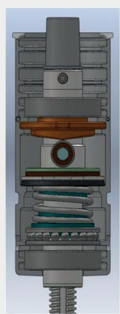

RH360R mechanism
360° rotation, height adjustment with clutch and automatic return to centre

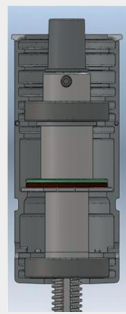

RH360L mechanism
360° rotation, height adjustment, clutch

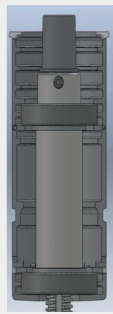

RHS360L mechanism
360° rotation, height adjustment



R360R mechanism
360° seat rotation with clutch and automatic return to centre

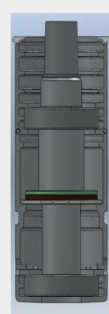

R360L mechanism
360° seat rotation with clutch

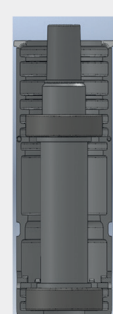

RS360L mechanism
360° seat rotation

OPTIONS



Comfort Plus



Embroidered logo



Decorative stitching



Decorative buttons



Decorative piping



Bicolor



Massage system

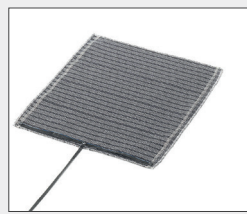

Heating system



Shepherd casters



Fix Base



Gas Piston



Removable lining

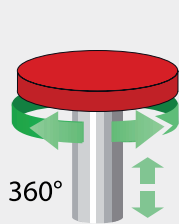

360°
PM (Multifunction Pump): 360° seat rotation with automatic return to centre and to maximum height

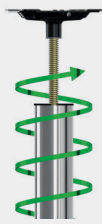

Clutch - Automatic return to centre
16 cm - 6.30"
Height adjustment



Use of fireproof upholstery with certificate upon request



Antibacterial Coatings and paints

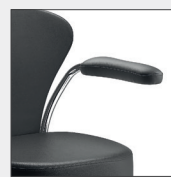

Armrests



Handle

INSTALLATIONS



BELLAGIO CASINO (KAZAKHSTAN)



LE CASINO (MONTE CARLO)



MILLIONAIRES CASINO (KENYA)



CASINO IMPÉRIAL PALACE ANNECY (FRANCE)



CASINO CAESARS WINDSOR (CANADA)



CASINO SCHAANWALD (LIECHTENSTEIN)

INSTALLATIONS



CLUB LIBERTÉ (SEYCHELLES)



COSTA VENEZIA CRUISESHIP (COSTA)



GOLDEN PALACE CASINO (FRANCE)



MSC SPLENDIDA CRUIESHIP (MSC)



BARRIÈRE CLUB PARIS (FRANCE)



SOCHI CASINO & RESORT (RUSSIA)

INSTALLATIONS

BELLAGIO
LAS VEGAS



BELLAGIO
LAS VEGAS



INSPIRATIONS

SLOT BASES



Safety certification for products installed on board of ships

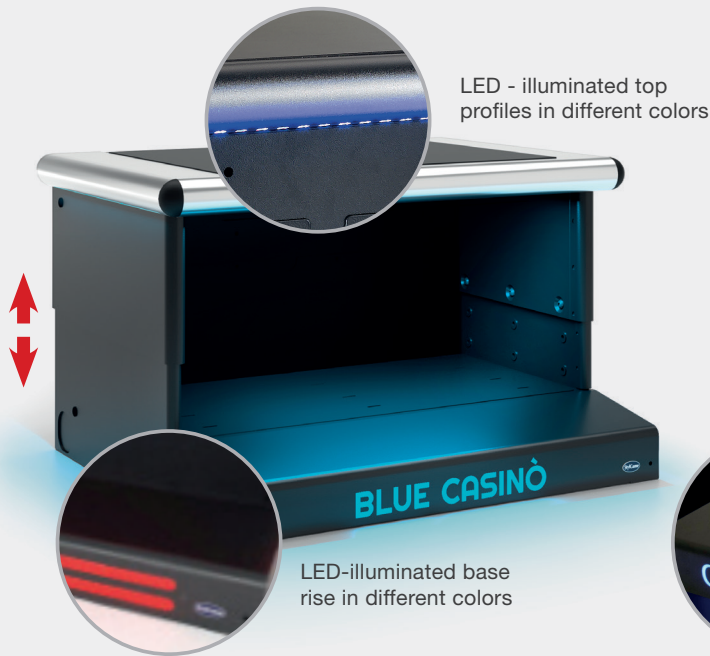

Removable slot fixing panel in laminated plywood

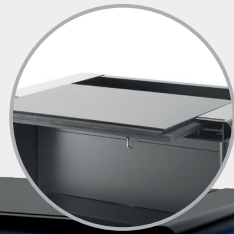

Footrest with lit customer's logo

ADJUSTABLE HEIGHT SLOT BASES MOD. TOP

FIXED HEIGHT SLOT BASES MOD. TOP



Spacer: 10 cm - 3.94" or 15 cm - 5.9" with adjustable accessories tray

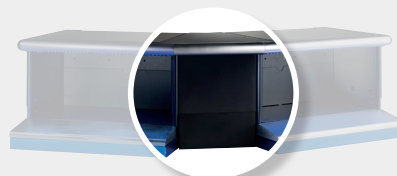

45°/60°/72°/90°/120° angle option

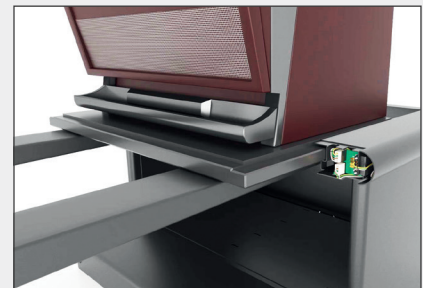

Slot fixing panel in laminated plywood, easily removable from the slot frame to allow machine replacement

DIMENSIONS

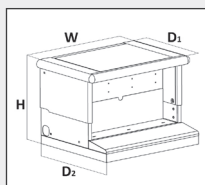

ADJUSTABLE HEIGHT
 W 70 cm - 27,56"
 D1 50 cm - 19,69"
 D2 60 cm - 23,62"
 H from 35 to 50 cm - 13,78" to 19,69"
 (adjustment every 5 cm - 1,97")
 * Customized dimensions available

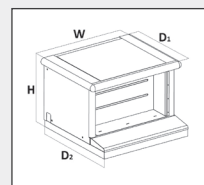

FIXED HEIGHT
 W 70 cm - 27,56"
 D1 50 cm - 19,69"
 D2 60 cm - 23,62"
 H 45 cm - 17,72"
 * Customized dimensions available

SE
B
S



**ADJUSTABLE HEIGHT SLOT BASES
MOD. LITE**

**FIXED HEIGHT SLOT BASES
MOD. LITE**

DIMENSIONS

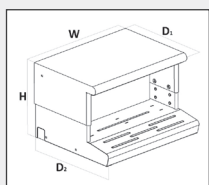

ADJUSTABLE HEIGHT
 W 70 cm - 27,56"
 D1 50 cm - 19,69"
 D2 60 cm - 23,62"
 H from 35 cm to 50cm - 13,78" to 19,69"
 (adjustment every 5 cm - 1,97")
 * Customized dimensions available

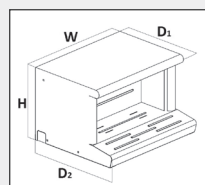

FIXED HEIGHT
 W 70 cm - 27,56"
 D1 50 cm - 19,69"
 D2 60 cm - 23,62"
 H 45 cm - 17,72"
 * Customized dimensions available

SLOT BASES CONFIGURATION EXAMPLES

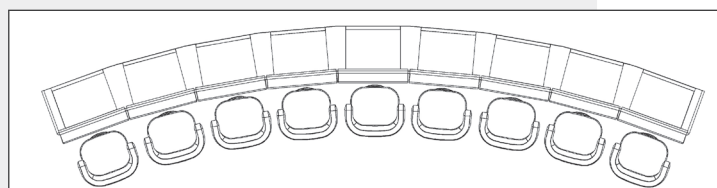
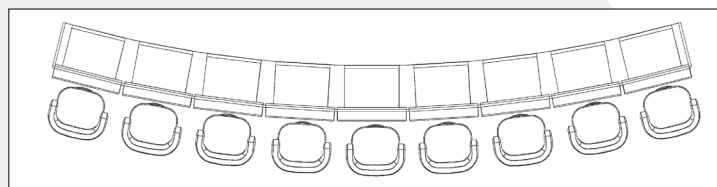
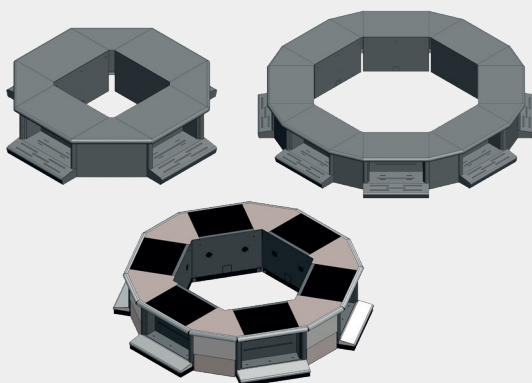

BINGO DIVISION

BINGO TABLES

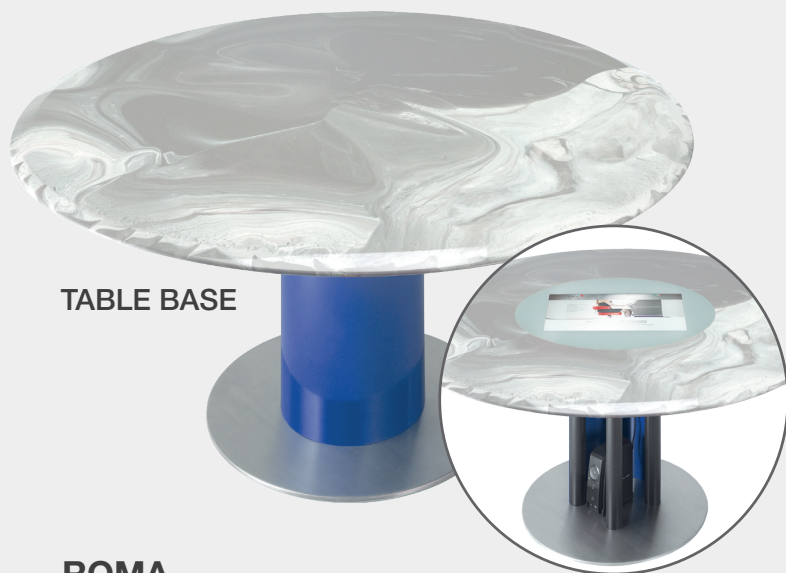

TABLE BASE

ROMA

Post diameter: Ø13,78" (350 mm)
Ready to host devices and cables



MILANO

Post diameter: Ø7,6" (193mm)

TABLE TOP

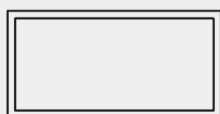

RECTANGULAR

- Standard size: 55,1" x 27,56" (1400x700 mm)
- Customized dimensions available
- Available with customized hole for monitor hosting
- Edge shapes: straight – beveled
- Materials: polymerized marble – laminate

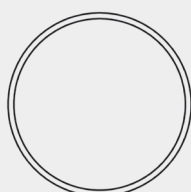

ROUNDED

- Standard sizes: Ø43,3" - Ø51,2" - Ø59" - Ø63" (Ø1100 - Ø1300 - Ø1500 - Ø1600mm)
- Customized dimensions available
- Available with customized hole for monitor hosting
- Edge shapes: straight – beveled – half bullnose
- Materials: polymerized marble – laminate

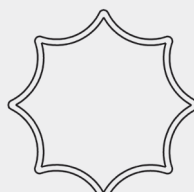

CUSTOMIZED SHAPE

- Customized shape and dimensions
- Available with customized hole for monitor hosting
- Edge shape: straight
- Materials: polymerized marble – laminate

EDGE

STRAIGHT

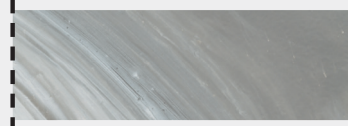

BEVELED



HALF BULLNOSE

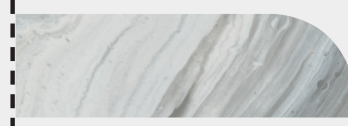

SEATS



TOWER FREE
MONTERREY



TOWER WHEELS
SANREMO



TOWER FREE
MONTREAL



TOWER FREE
ROME



TOWER WHEELS
LUGANO



TOWER WHEELS
CORTINA



TOWER WHEELS
BILBAO



various types of armrest available



various types of gliders and casters available



customizable upholstery available for each model

SERVICE CALL



WHAT IS IT?

Service Call is a customer assistance system which prevents the player from leaving the playing station.

WHY CHOOSING IT?

- INCREASES THE HALL'S REVENUE
- OFFERS A PROMPT SERVICE THAT DISTINGUISHES THE HALL AND RETAINS THE CUSTOMER
- HELPS PLANNING STAFF'S TASKS
- MAKES THE STAFF'S JOB EASIER AND ALLOWS THE BEST MANAGEMENT OF THE FOLLOWING TASKS

CASH DESK



BAR RESTAURANT



TECHNICAL SUPPORT



WHO IS IT SUITABLE FOR?

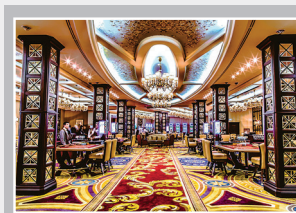

CASINOS

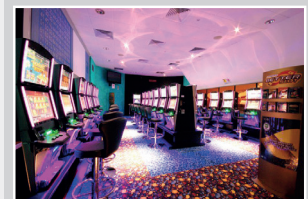

GAMING HALLS



BINGO HALLS



BOWLING HALLS

...ANY ACTIVITY INVOLVING A DIRECT SERVICE TO THE CUSTOMER



HOW DOES IT WORK?

SERVICE CALL IS A STAND-ALONE SYSTEM, WORKS INDEPENDENTLY AND DOES NOT INTERFERE WITH OTHER SYSTEMS USED IN THE HALL. IT DOES NOT REQUIRE ANY EXISTING COMMUNICATION LINE AND IT HAS VIRTUALLY NO RUNNING COSTS.

Devices for casino and gaming halls feature:

- 3 call buttons;
- 1 or 2 USB ports for battery charge of mobile phones or other devices;
- 1 support surface which lights up when the USB port is in use, as a reminder for the player.

The device dedicated to bingo halls consists of a push button to be placed in the middle of the table, easily reachable by each player.

The calls reception may be managed through one or more smart-phones, tablets or smart-watches, according to the number of employees working in the hall.

The system shows exactly from which device in the hall the call is coming.

The visualization of the device position on the hall layout allows the staff to give a quick and efficient service to the customer.

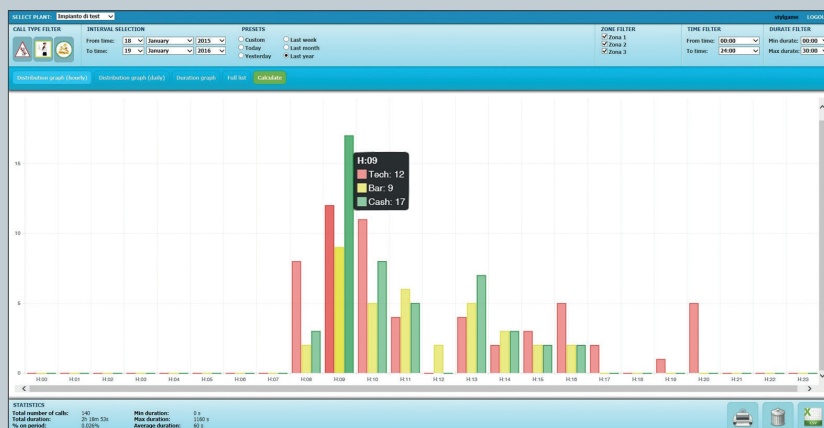

The system is supported by a dedicated software through which the hall manager controls the operations and the statistics related to the service offered, even if remotely connected through the web.

The interface is customizable in terms of graphics. Data can be transferred via the internet to a centralized control system for further processing.

BINGO DIVISION INSTALLATIONS



SERVICE CALL INSTALLATIONS



INSTALLATIONS

SPORTSBOOK DIVISION

FORTUNE CHAIR

Fortune is a chair with innovative design and construction features, allowing for a wide choice of customizations; it is a totally unique product which offers numerous advantages both during installation and customer experience.



INNOVATIVE TECHNICAL SOLUTIONS FOR: COMFORT, INSTALLATION & MAINTENANCE

WITH **COMFORT PLUS®**
BUILT TO PROVIDE MAXIMUM COMFORT

Comfort Plus® exclusive material with unique physical features:

- Highly resilient and breathable
- Creates a massage that stimulates the cutaneous microcirculation of the body parts in contact with the chair.



EASY TO CLEAN
AND MAINTAIN

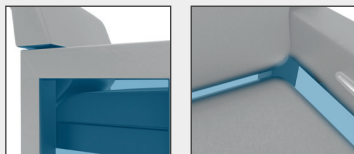
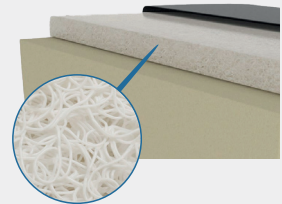

Designed to prevent the deposit of dust in the least accessible areas



Easy to disassemble to facilitate deep cleaning

Completely removable upholstery for easy replacement and maintenance

EASY TO STOCK AND CARRY



Legs and frame



Bottom cushion



Backrest

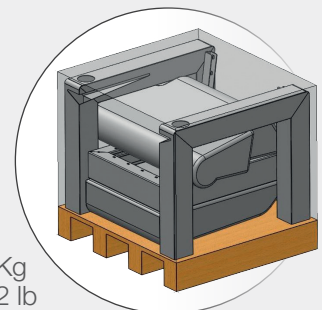

40 Kg
88,2 lb

OPTIONALS



Headrest



Headrest with speakers



Folding table

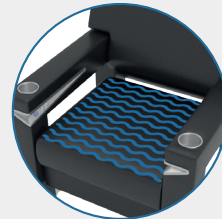

Massage system

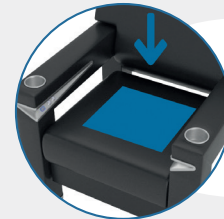

Pressure sensor

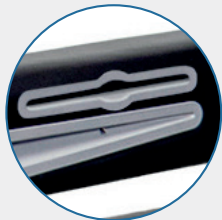

Wireless smartphone charger

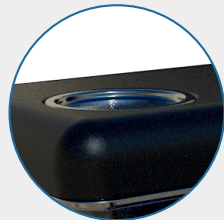

Ashtray or cupholder



Volume and channel control

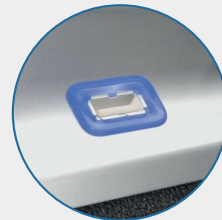

Charging USB ports

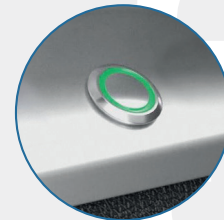

Service Call®



Headphones jack

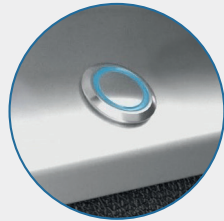

On/Off audio command

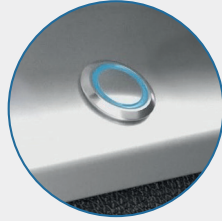

On/Off massage command

Thanks to specific structural elements, also with the Fortune chair it is possible to create any type of layout, depending on size and shape of the area.



Spacer for linear composition



Angular spacers



Spacer with trash bin



Squared spacer



CUSTOM **OEM** PROJECTS

ARISTOCRAT

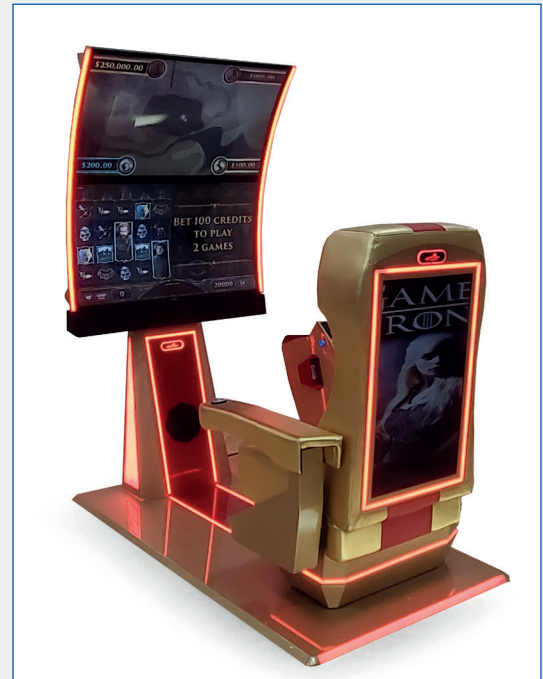



KONAMI



PROTECTION SEPARATORS

PROTECTION SEPARATORS FOR SLOTS

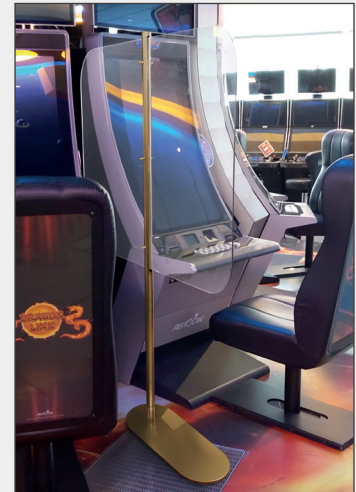

SPECIFICATIONS

- Panel thickness 6 mm / 0.23 in, dimensions w100xh100 cm / 39.37x39.37 in (customizable)
- Powder coated steel pole, standard color hammered black (customizable)
- Mounting plate with pre punched holes to be screwed to the slot stand or to the floor
- Pole height from the top of slot stand 135cm/53.15in (customizable, depending on the slot stand height)
- Pole height from the floor 180cm/70.37in (customizable)

OPTIONS

- 10 kg/22lb Powder coated steel base plate for self-standing pole
- 90° mounting bracket to be used with the 135 cm high pole
- Screen-printed panel
- Antibacterial paint
- Filling spacer between slot machines in hardboard (Faesite) (customizable dimensions)



PROTECTION SEPARATORS FOR BINGO TABLES



SPECIFICATIONS

- Panel thickness 6 mm/0.23in. for round table Ø 130 cm/51.18in, dimensions W100x h60 cm/39.37x23.62in (customizable)
- Powder coated steel table mounting bracket or self-standing by means of mounts with double sided tape

OPTIONS

Screen-printed panel



PROTECTION SEPARATORS FOR GAMING TABLES



SIDE PROTECTION



FULL PROTECTION

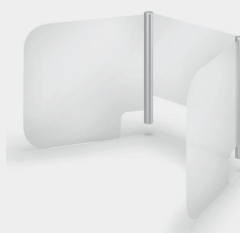

SPECIFICATIONS

- Panel thickness 6 mm/0.23in, dimensions W100xh100cm/39.37x39.37in (customizable)
- Powder coated steel pole, standard color hammered black (customizable)

OPTIONS

- Screen-printed panel
- Antibacterial paint

SIDE PROTECTION:

Pole height from the floor 180cm/70.37in (customizable) with 10 kg/22lb Powder coated steel base plate

FULL PROTECTION:

Self standing h 180/70.37 in (customizable) with 10 kg/22lb Powder coated steel base plate, or table mounting

ACCESSORIES



TECH SERVICE TRAY
FOR SLOT BANKS



SERVICE TABLE



ROUND TOP TABLE



ROUND TOP TABLE
WITH UPPER RING



SQUARE TOP TABLE

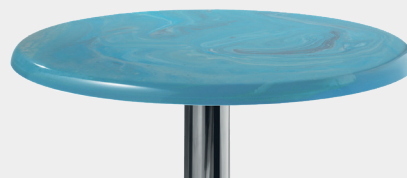

ROUND TOP TABLE IN
POLYMERIZED MARBLE
OR LAMINATE



CORD STANCHIONS

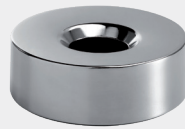

TABLE ASHTRAY



ASHTRAY



DISPLAY
STAND

BROCHURE
HOLDER

GADGET HOLDER



MENU HOLDER

ACCESSORIES



EQUIPMENT FOR CASINOS AND GAMING

StylGame Srl

Via Cav. di Saluzzo 2-10B (Z.I. Cosa) 33097 Spilimbergo (PN) Italy
Tel. +39 0427 595011 - Fax +39 0427 841091
Skype: stylgame - Email: sales@stylgame.com
GPS: 46°06'37.41"N 12°52'37.76"E

StylGame USA, LLC

6485 W Sunset Road, Suite 100 Las Vegas, NV 89118 USA
Tel. +1 702 750 0660
Skype: stylgame36 - Email: salesusa@stylgame.com
GPS: 36°04'15.142"N 115°13'56.928"W

DISTRIBUTED BY



**StylGame Srl®: visit our web site
www.StylGame.com**